

Connector, SMA Female End launch 0.5T

P.N. : C-RSMF.EL05.1

Dimension

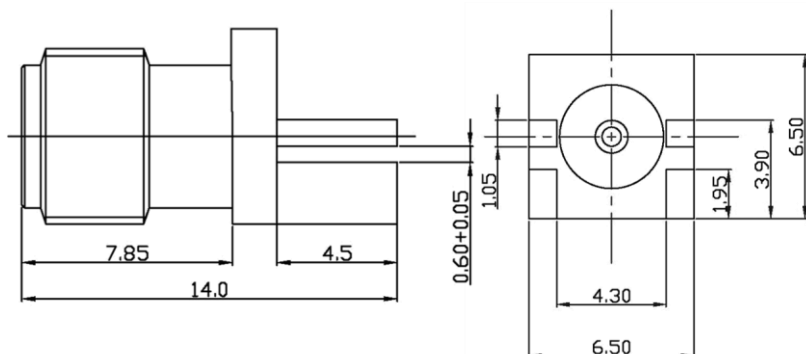

Photo



Electrical specification

Frequency Range	DC ~ 18GHz
Impedance	50 Ohm
Insertion Loss	0.05 \sqrt{f} (GHz)
V.S.W.R.	<1.12 + 0.01f(GHz)
Contact Current	DC 2.0A max
Insulation Resistance	5,000 M Ω min
Working Voltage	335 VRMS max
Dielectric Withstanding Voltage	750V min
RF leakage	-60dBm min., between 2~3GHz

Material specification

Connector Body	Gold Plating Brass
Connector Center Contact	Gold Plating BeCu
Insulator	PTFE
Connector Mating	500 cycles

Environmental specification

Corrosion resistance	MIL-STD-202, Method 101, Condition B
Moisture resistance	MIL-STD-202, Method 106
Thermal shock	MIL-STD-202, Method 107, Condition B
Vibration	MIL-STD-202, Method 204, Condition D
Operating Temperature	-65°C ~ 125 °C
RoHS	Compliant